



-  ATTREZZATURE
-  HOOKLIFTS
-  HAKENGERÄTE
-  POLYBENNES
-  EQUIPOS



La TAM, forte di un'esperienza trentennale e di un ampio know-how nel settore metalmeccanico e oleodinamico, ha dato slancio alla produzione di attrezzature dedicate al trasporto ed alla movimentazione di container. TAM ha fatto della qualità dei prodotti e del servizio il proprio punto di forza. E' certificata secondo le norme UNI EN ISO 9001 – 2000 ed è codificata Nato AF770.

Thanks to a thirty years experience and a wide know-how in the mechanical and hydraulic field, TAM company has given strength to the production of hooklifts dedicated to transport and handle containers. TAM force point is products quality and service. TAM company is certified according to UNI EN ISO 9001-2000 norms and has NATO AF770 codification.

Durch eine dreißigjährige Erfahrung und ein groß Know-how in mechanischem und hydraulischem Gebiet hat TAM Elan an die Geräteproduktion gegeben, welche für den Transport und die Handlung Container bestimmt sind. Seine Kraft ist Produktenqualität und Dienst. Bescheinigt gemäß UNI EN ISO 9001-2000 und NATO AF770 kodifiziert.

TAM grâce à son expérience de trente ans et à son grand know-how dans le secteur mécanicien et hydraulique a donné élan à la production de systèmes dédiés au transport et à la manutention de conteneurs. Elle a fait de la qualité des produits et du service son point de force. Elle est certifiée selon la norme UNI EN ISO 9001-2000 et codifiée NATO AF770.

TAM desde su experiencia de más de treinta años y de grande competencia en el mundo de la construcción y oléodinamico empezó a la producción de equipos de ganchos para el cargo y movimentación de container. TAM hizo de la calidad de sus productos y del servicio su fuerza. Fue certificada conforme tanto con las reglas UNI EN ISO 9001-2000 como NATO AF770.



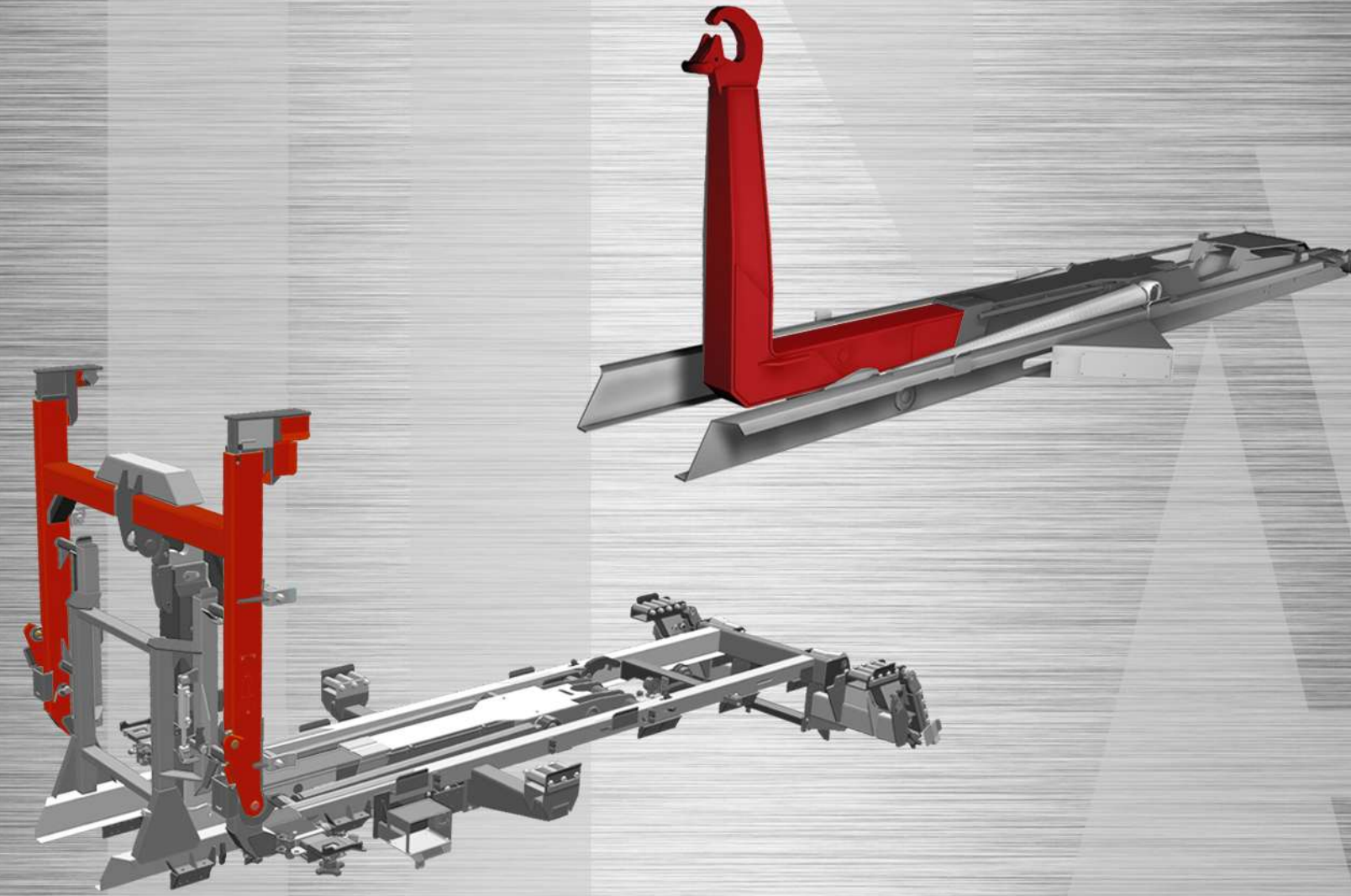

 Attrezzature scarrabili per trasporto e movimentazione container.

 Hooklifts for containers transport and handling.

 Hakengeräte für den Transport und die Handlung von Container.

 Systèmes lève - conteneurs pour le transport et la manutention de conteneurs.

 Equipos de ganchos para el cargo y movimentación de container.

SCHEDATECNICA
ATTREZZATURA CON POTENZA FISSA

DATASHEET
FIXED ARM HOOKLIFT

TECHNISCHE DATENQUE
SCHUBARM - HAKENGERÄT

FICHETECHNIQUE
SYSTEME LEVE CONTENEUR A POTENCE

FICHATÉCNICA
EQUIPO CON GANCHO FIJO

TIPO ATTREZZATURA MODEL MODELL MODÈLE MODELO
T 3
T3 S
T 4
T 5 - H 900
T 5 - H 900
T 5 - H 1480
T 7 - H 900
T 7 - H 1480
T 8
T 10
T 12
T 14
T 16
T 18
T 20
T 25
T 40

PTT VEICOLO GVW Zul. LKW-GESAMTGEWICHT PTC VEHICULE PMA VEHICULO
3T - 5T
3T - 5T
3T - 5T
5T - 8T
5T - 8T
5T - 8T
8T - 10T
8T - 10T
8T - 10T
10T - 12T
12T - 14T
14T - 16T
16T - 19T
19T - 26T
19T - 26T
26T - 32T
40T

PESO WEIGHT GEWICHT POIDS PESO Kg.
485 -500
515
500 -515
580
970
750 -810
1020
800 -870
800 -870
1350 -1450
1410 -1510
1920 -2080
2000 -2155
2100 -2310
2350 -2850
2450 -2900
2630 -2970
3100 -3450

CAPACITA' DI SOLLEV. LIFTING CAP. HUBKRAFT CAP. DE LEVAGE POTENCIA DE ELEVACIÓN
3 T
3 T
4 T
5 T
5 T
5 T
7 T
7 T
8 T
10 T
12 T
14 T
16 T
18 T
20 T
25 T
32 T

LUNGHEZZA ATTREZZATURA HOOKLIFT LENGTH GERÄTELÄNGE LONGUEUR DU SYSTEME LARGO DEL EQUIPO	
MIN	MAX
2600	3200
2700	
2600	3200
3000	3200
3600	3800
3200	3700
3600	3800
3200	3700
3500	4700
3500	4700
4200	5300
4200	5300
4500	5600
4500	6600
4500	6600
5000	6600
5000	6600

LUNGHEZZA UTILE CASSONE CONTAINER INTERNAL LENGTH NUTZLÄNGE DES CONTAINERS LONGUEUR UTILE DU CAISSON LARGO INTERNO DE LA CAJA	
MIN	MAX
2400	3650
2200	3300
2400	3650
2750	3650
3150	4250
2850	4150
3150	4250
2850	4150
3200	5300
3200	5300
3600	5900
3600	5900
3900	6200
3900	7200
3900	7200
4400	7200
4400	7200

- ATTREZZATURE SCARRABILI
- HOOKLIFTS
- HAKENGERÄTE
- SYSTEMES LÈVE - CONTENEURS A CROCHET
- EQUIPOS DE GANCHO

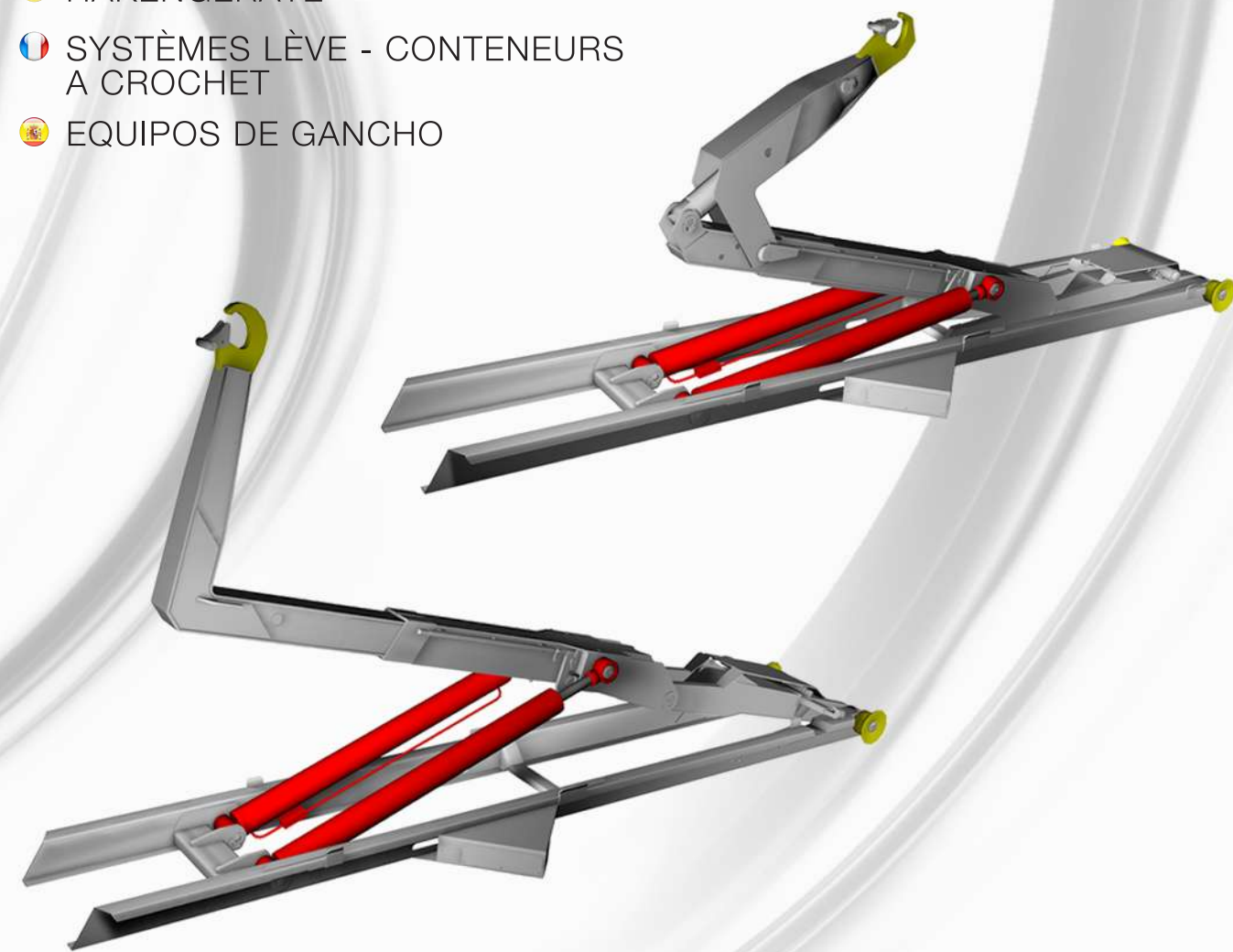

SCHEDATECNICA
ATTREZZATURA CON POTENZA SNODATA

DATASHEET
ARTICULATED ARM

TECHNISCHE DATENQUE
SCHUBKNICKARM - HAKENGERÄT

FICHETECHNIQUE
SYSTEME LEVE CONTENEUR A POTENCE ARTICULEE

FICHATÉCNICA
EQUIPO CON GANCHO ARTICULADO

TIPO ATTREZZATURA MODEL MODELL MODÈLE MODELO
T 14 SN
T 16 SN
T 18 SN
T 20 SN
T 25 SN

PTT VEICOLO GVW Zul. LKW-GESAMTGEWICHT PTC VEHICULE PMA VEHICULO
14T - 16T
16T - 19T
19T - 26T
19T - 26T
26T - 32T

PESO WEIGHT GEWICHT POIDS PESO Kg.
2300 -2600
2380 -2680
2450 -2800
2560 -2910
3200 -3350

CAPACITA' DI SOLLEV. LIFTING CAP. HUBKRAFT CAP. DE LEVAGE POTENCIA DE ELEVACIÓN
14 T
16 T
18 T
20 T
25 T

LUNGHEZZA ATTREZZATURA HOOKLIFT LENGTH GERÄTELÄNGE LONGUEUR DU SYSTEME LARGO DEL EQUIPO	
MIN	MAX
4500	5400
4500	5400
4500	6200
4500	6200
5400	6600

LUNGHEZZA UTILE CASSONE CONTAINER INTERNAL LENGTH NUTZLÄNGE DES CONTAINERS LONGUEUR UTILE DU CAISSON LARGO INTERNO DE LA CAJA	
MIN	MAX
3300	6000
3300	6000
3300	6800
3300	6800
3800	7200

🇮🇹 ATTREZZATURE SCARRABILI

🇬🇧 HOOKLIFTS

🇪🇸 HAKENGERÄTE

🇫🇷 SYSTÈMES LÈVE - CONTENEURS A CROCHET

🇵🇹 EQUIPOS DE GANCHO





ATTREZZATURE SCARRABILI

HOOKLIFTS

HAKENGERÄTE

SYSTÈMES LÈVE - CONTENEURS A CROCHET

EQUIPOS DE GANCHO



BLOCCAGGI ANTERIORI ADR



CILINDRO AIUTO RIBALTAMENTO



RULLO POSTERIORE DI SCORRIMENTO



ALTEZZA GANCIO VARIABILE



PANNELLO SINOTTICO E COMANDI PNEUMATICI



SISTEMA LOGICA PROGRAMMABILE



ATTACCHI RAPIDI POSTERIORI PER UTILIZZI



GANCIO DI SOLLEVAMENTO



RULLO STABILIZZATORE VERTICALE

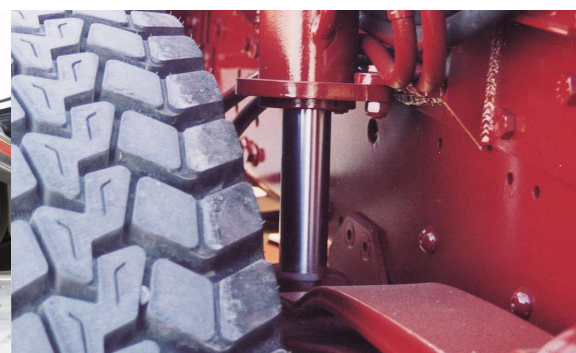

BLOCCAGGI AL PONTE



BLOCCAGGIO INTERNO CON CARTER DI PROTEZIONE



BLOCCAGGIO ESTERNO CON CARTER DI PROTEZIONE



**COMPATTATORE
MONOPALA**

Lunghezza mm

TAM	12	5200
TAM	16	5600
TAM	20	6200
TAM	22	6500
TAM	24	7100

PORTA MANUALE
PORTA IDRAULICA
MOTORE DIESEL

COPERTURA BOCCA DI CARICO



**COMPATTATORE
A CASSETTO**

Lunghezza mm

TAM	12	5200
TAM	16	5600
TAM	20	6200
TAM	22	6500
TAM	24	7100

PORTA MANUALE
PORTA IDRAULICA
MOTORE DIESEL

COPERTURA BOCCA DI CARICO



🇮🇹 RIMORCHI
PORTA CONTAINERS

🇮🇹 TRAILERS FOR
CARRYING CONTAINERS

🇩🇪 ANHÄNGER MIT AUSRÜSTUNG
FÜR CONTAINER

🇫🇷 REMORQUES AVEC SYSTEME
PORTE CONTENEURS

🇪🇸 REMOLQUES PARA
TRANSPORTAR CONTAINER



RIMORCHIO
PORTA CONTAINER

SCARRABILE
SCARRABILE RIBALTABILE

2 ASSI
3 ASSI

SOSPENSIONI MECCANICHE
SOSPENSIONI PNEUMATICHE

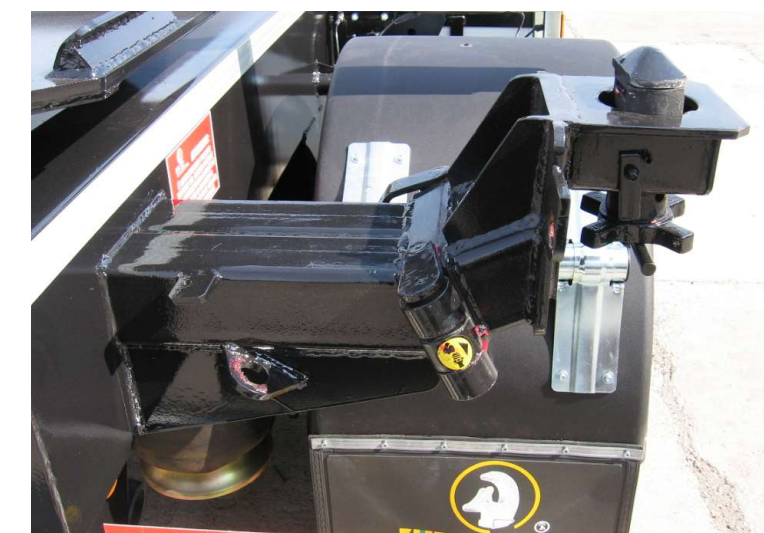

🇮🇹 PRESSE STAZIONARIE

🇬🇧 FIXED PRESSES

🇩🇪 STÄNDIGE PRESSEN

🇫🇷 PRESSES FIXES

🇪🇸 PRENSAS ESTACIONARIAS



*PRESSA
STAZIONARIA*

		<i>Kw</i>
<i>T</i>	200	7,5
<i>T</i>	300	15
<i>T</i>	500	15
<i>T</i>	800	30

*GANCI MECCANICI
GANCI IDRAULICI
TRASLATORE PER CASSONI
STAZIONI DI TRASFERIMENTO*

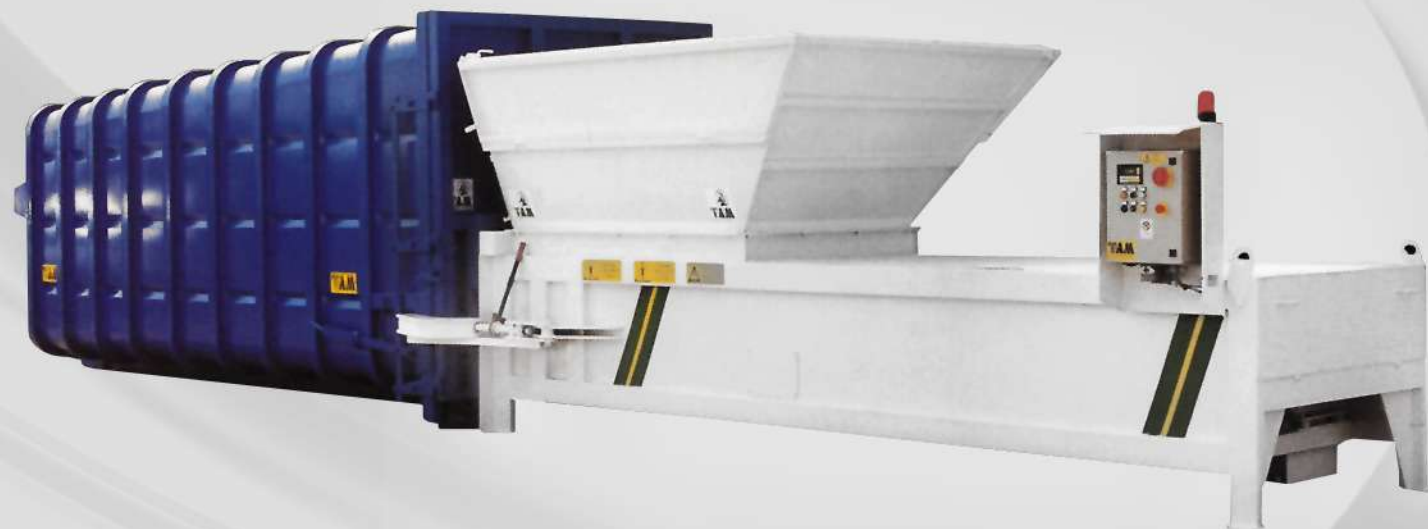



Sede Legale

Via E.Mattei, 16 - 25026 Ponteviso (BS)
Tel. (+39) 030 9930433/443 - Fax (+39) 030 9930456

Stabilimenti

Via E.Mattei, 16 - 25026 Ponteviso (BS)
Zona Industriale Punta Penna - 66054 Vasto (CH)

Web

tam@rozzi.it
www.rozzi.it

Certificazioni

